



Low-Cost, Low-Dropout, Dual Linear Regulator

MAX8862

General Description

The MAX8862 low-cost, low-dropout, dual linear voltage regulator is ideal for battery-powered and portable applications. The regulators have independent supply inputs and provide 250mA and 100mA, respectively, with a full-load dropout voltage of 160mV. Both regulators use P-channel MOSFET pass transistors and maintain low quiescent current independent of load current. In dropout, the MOSFET does not suffer from excessive base currents, as do saturated PNP transistors.

The MAX8862 output voltage is preset to 4.95V (L), 3.175V (T), or 2.85V (R). This device employs Dual Mode™ operation, allowing user-adjustable outputs from +2V to +11V with external resistors. The input supply-voltage range is 2.5V to 11.5V. Other features include independent shutdown, power-good indicator, short-circuit and reverse-battery protection, and thermal shutdown.

The MAX8862's regulators are ideal power supplies for the radio and the microcontroller (μC) used in digital, cordless, and PCS phones. The main regulator is optimized for superior transient and dynamic response, while the secondary regulator exhibits low-output, wide-band noise.

The MAX8862 comes in a 16-pin SO package with a lead frame that uses multiple GND pins as a heat sink for additional thermal dissipation.

Applications

- | | |
|---------------------|-----------------------|
| Cellular Phones | Cordless Phones |
| PCS Phones | PCMCIA Cards |
| Modems | Hand-Held Instruments |
| Electronic Planners | |

Typical Operating Circuit

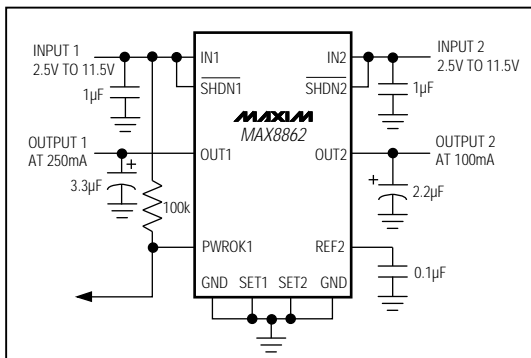

Dual Mode is a trademark of Maxim Integrated Products.

Features

- ♦ **Low Cost**
- ♦ **Guaranteed 250mA and 100mA Output Currents, with Current Limiting**
- ♦ **Dual Mode Operation:**
Fixed or Adjustable Output from +2V to +11V
- ♦ **+2.5V to +11.5V Input Range**
- ♦ **160mV Dropout Voltage at 200mA Output Current**
- ♦ **Low Supply Current—Even in Dropout**
200μA Operating
<1μA Shutdown
- ♦ **Power-Good Indicator**
- ♦ **Reverse-Battery Protection**
- ♦ **Thermal Overload Protection**

Ordering Information

PART*	TEMP. RANGE	PIN-PACKAGE
MAX8862_ESE	-40°C to +85°C	16 Narrow SO

*Insert the desired suffix letter (from the table below) into the blank to complete the part number.

SUFFIX	FIXED OUTPUT VOLTAGE (V)
L	4.95
T	3.175
R	2.85

Pin Configuration

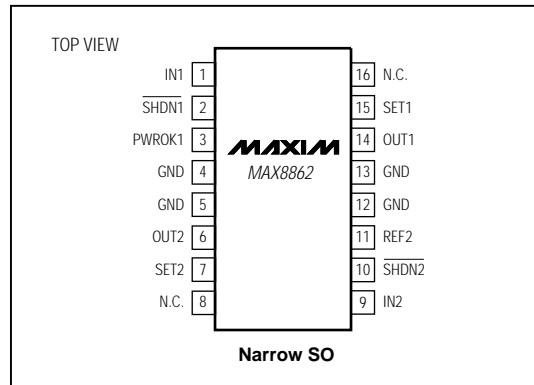

Low-Cost, Low-Dropout, Dual Linear Regulator

MAX8862

ABSOLUTE MAXIMUM RATINGS

IN1, IN2 to GND (Note 1).....	±12V	Operating Temperature Range	-40°C to +85°C
SET1, SHDN1, PWROK1 to GND	-0.3V to (VIN1 + 0.3V)	Junction Temperature	+150°C
SET2, SHDN2, REF2 to GND	-0.3V, (VIN2 + 0.3V)	Storage Temperature Range	-65°C to +150°C
Output Short-Circuit Duration	Infinite	Lead Temperature (soldering, 10sec)	+300°C
Continuous Power Dissipation (TA = +70°C)			
16-Pin Narrow SO (derate 20mW/°C above +70°C)	1W		

Note 1: Connect SHDN1 to IN1 and SHDN2 to IN2 through 20kΩ resistors to limit current flow in case a battery is reversed.

Stresses beyond those listed under "Absolute Maximum Ratings" may cause permanent damage to the device. These are stress ratings only, and functional operation of the device at these or any other conditions beyond those indicated in the operational sections of the specifications is not implied. Exposure to absolute maximum rating conditions for extended periods may affect device reliability.

ELECTRICAL CHARACTERISTICS (Notes 2, 3)

(VIN = VOUT(TYP) + 1V, TA = 0°C to +85°C, unless otherwise noted. Typical values are at TA = +25°C.)

PARAMETER	CONDITIONS		MIN	TYP	MAX	UNITS
Input Voltage Range			2.5		11.5	V
Output Voltage	0mA < IOUT1 ≤ 250mA, 0mA < IOUT2 ≤ 100mA	MAX8862L	4.80	4.95	5.15	V
		MAX8862T	3.050	3.175	3.300	
		MAX8862R	2.75	2.85	2.95	
Output Voltage Range			2		11	V
Maximum Output Current	VIN1 = 2.5V min, VOUT1 = 2V		250			mA
	VIN2 = 2.5V min, VOUT2 = 2V		100			
Current Limit	IOUT1		580			mA
	IOUT2		250			
Quiescent Current			200	330		μA
Shutdown Supply Current	VIN1 = VIN2 = 11.5V		0.01	1		μA
Dropout Voltage (Note 4)	IOUT1 = IOUT2 = 1mA		1.5			mV
	IOUT1 = 200mA, MAX8862L/T		160	330		
	IOUT2 = 100mA, MAX8862L/T		160	350		
	IOUT1 = 200mA, MAX8862R		165	350		
	IOUT2 = 100mA, MAX8862R		180	400		
Line Regulation	IOUT1 = IOUT2 = 15mA	VIN1 = (VOUT1 (TYP) + 1V) to 11.5V	0.03	0.1		%V
		VIN2 = (VOUT2 (TYP) + 1V) to 11.5V	0.02	0.08		
Load Regulation	IOUT1 = 0mA to 250mA, COUT1 = 3.3μF		0.015			%mA
	IOUT2 = 0mA to 100mA, COUT2 = 2.2μF		0.02			
OUT2 Voltage Noise	COUT2 = 2.2μF ZOUT2 = 10mA	10Hz < f < 100kHz	277			mVRMS
		10Hz < f < 1MHz	875			
	COUT2 = 100μF ZOUT2 = 10mA	10Hz < f < 100kHz	211			
		10Hz < f < 1MHz	667			
REFERENCE						
REF2 Output Voltage	CREF2 = 0.1μF		1.230	1.250	1.270	V
REF2 Line Regulation	VIN2 = 2.5V to 11.5V		1			mV
REF2 Load Regulation	IREF2 = 0μA to 10μA		6			mV

Low-Cost, Low-Dropout, Dual Linear Regulator

MAX8862

ELECTRICAL CHARACTERISTICS (Notes 2, 3)

($V_{IN} = V_{OUT(TYP)} + 1V$, $T_A = 0^{\circ}C$ to $+85^{\circ}C$, unless otherwise noted. Typical values are at $T_A = +25^{\circ}C$.)

PARAMETER	CONDITIONS	MIN	TYP	MAX	UNITS
PWROK1 OUTPUT					
PWROK1 Trip Voltage	Falling edge at SET1	1.175	1.200	1.225	V
PWROK1 Hysteresis	Rising edge at SET1		15		mV
PWROK1 Leakage Current	$V_{PWROK1} = 11.5V$		0.01	1	μA
PWROK1 Low Voltage	$I_{SINK} = 0.5mA$		25	200	mV
SHDN					
SHDN_ Logic Low	Shutdown mode, $V_{IN} = V_{OUT(TYP)} + 1V$ to 11.5V			0.45	V
SHDN_ Logic High	Active mode, $V_{IN} = 11.5V$	1.8			V
SHDN_ Leakage Current	$V_{SHDN} = 11.5V$		0.01	1	μA
SET_ INPUT					
SET_ Reference Voltage	$SET_ = OUT_$, $I_{OUT1} = I_{OUT2} = 15mA$	1.23	1.25	1.28	V
SET_ Input Bias Current	$V_{SET_} = 1.30V$		0.01	0.1	μA
SET_ Threshold	Internal feedback			40	mV
	External feedback	250			
THERMAL PROTECTION					
Thermal Shutdown Temperature			160		$^{\circ}C$
Thermal Shutdown Hysteresis			20		

ELECTRICAL CHARACTERISTICS (Notes 2, 3)

($V_{IN} = V_{OUT(TYP)} + 1V$, $T_A = -40^{\circ}C$ to $+85^{\circ}C$, unless otherwise noted. Typical values are at $T_A = +25^{\circ}C$.)

PARAMETER	CONDITIONS	MIN	TYP	MAX	UNITS	
Input Voltage Range		2.5		11.5	V	
Output Voltage	$0mA < I_{OUT1} \leq 250mA$, $0mA < I_{OUT2} \leq 100mA$	MAX8862L	4.80	4.95	5.15	V
		MAX8862T	3.050	3.175	3.300	
		MAX8862R	2.740	2.85	2.960	
Output Voltage Range		2		11	V	
Maximum Output Current	$V_{IN1} = 2.5V$ min, $V_{OUT1} = 2V$	250			mA	
	$V_{IN2} = 2.5V$ min, $V_{OUT2} = 2V$	100				
Current Limit	I_{OUT1}		580		mA	
	I_{OUT2}		250			
Quiescent Current			200	330	μA	
Shutdown Supply Current	$V_{IN1} = V_{IN2} = 11.5V$		0.01	1	μA	
Dropout Voltage (Note 4)	$I_{OUT1} = I_{OUT2} = 1mA$		1.5		mV	
	$I_{OUT1} = 200mA$, MAX8862L/T		160	330		
	$I_{OUT2} = 100mA$, MAX8862L/T		160	350		
	$I_{OUT1} = 200mA$, MAX8862R		165	350		
	$I_{OUT2} = 100mA$, MAX8862R		180	400		

Low-Cost, Low-Dropout, Dual Linear Regulator

MAX8862

ELECTRICAL CHARACTERISTICS (Notes 2, 3) (continued)

($V_{IN_} = V_{OUT_}(TYP) + 1V$, $T_A = -40^{\circ}C$ to $+85^{\circ}C$, unless otherwise noted. Typical values are at $T_A = +25^{\circ}C$.)

PARAMETER	CONDITIONS	MIN	TYP	MAX	UNITS
Line Regulation	$I_{OUT1} = I_{OUT2} = 15mA$ $V_{IN1} = (V_{OUT1}(TYP) + 1V)$ to 11.5V		0.03	0.12	%V
	$V_{IN2} = (V_{OUT2}(TYP) + 1V)$ to 11.5V		0.02	0.10	
Load Regulation	$I_{OUT1} = 0$ to 250mA, $C_{OUT1} = 3.3\mu F$		0.015		%mA
	$C_{OUT2} = 2.2\mu F$, 10Hz < f < 1MHz, $I_{OUT2} = 10mA$		0.02		
OUT2 Voltage Noise	$C = 2.2\mu F$, $Z_{OUT2} = 10mA$	10Hz < f < 100kHz	-	277	μV_{RMS}
		10Hz < f < 1MHz	-	875	
	$C = 100\mu F$, $Z_{OUT2} = 10mA$	10Hz < f < 100kHz	-	211	
		10Hz < f < 1MHz	-	667	
REFERENCE					
REF2 Output Voltage	$C_{REF2} = 0.1\mu F$	1.217	1.250	1.277	V
REF2 Line Regulation	$V_{IN2} = 2.5V$ to 11.5V		1		mV
REF2 Load Regulation	$I_{REF2} = 0\mu A$ to 10 μA		6		mV
PWROK1 OUTPUT					
PWROK1 Trip Voltage	Falling edge at SET1	1.165	1.200	1.235	V
PWROK1 Hysteresis	Rising edge at SET1		15		mV
PWROK1 Leakage Current	$V_{PWROK1} = 11.5V$		0.01	1	μA
PWROK1 Low Voltage	$I_{SINK} = 0.5mA$		25	200	mV
SHDN					
SHDN_ Logic Low	Shutdown mode, $V_{IN_} = V_{OUT_}(TYP) + 1V$ to 11.5V			0.45	V
SHDN_ Logic High	Active mode, $V_{IN_} = 11.5V$	2.0			V
SHDN_ Leakage Current	$V_{SHDN_} = 11.5V$		0.02	1	μA
SET_ INPUT					
SET_ Reference Voltage	$SET_ = OUT_$, $I_{OUT1} = I_{OUT2} = 15mA$	1.220	1.250	1.290	V
SET_ Input Bias Current	$V_{SET_} = 1.30V$		0.01	0.1	μA
SET_ Threshold	Internal feedback			30	mV
	External feedback	250			
THERMAL PROTECTION					
Thermal Shutdown Temperature			160		$^{\circ}C$
Thermal Shutdown Hysteresis			10		

Note 2: Guaranteed by design for $T_A = -40^{\circ}C$.

Note 3: Guaranteed for a junction temperature (T_J) equal to the operating temperature range. E-grade parts are guaranteed by design to operate up to $T_J = +125^{\circ}C$. For T_J above $+125^{\circ}C$, specifications exceed the operating limits.

Note 4: Dropout voltage is ($V_{IN_} - V_{OUT_}$) when $V_{OUT_}$ falls to 100mV below its nominal value at $V_{IN_} = (V_{OUT_} + 1V)$. For example, the MAX8862 is tested by measuring the $V_{OUT_}$ at ($V_{IN_} = 5.95V$ for the MAX8862L, $V_{IN_} = 4.175V$ for the MAX8862T, and $V_{IN_} = 3.85V$ for the MAX8862R) then $V_{IN_}$ is lowered until $V_{OUT_}$ falls 100mV below the measured value.

Low-Cost, Low-Dropout, Dual Linear Regulator

Typical Operating Characteristics

($V_{IN1} = V_{IN2} = 5.3V$, $C_{IN1} = C_{IN2} = 1\mu F$, $C_{OUT1} = 3.3\mu F$, $C_{OUT2} = 2.2\mu F$, $SHDN1 = IN1$, $SHDN2 = IN2$. $T_A = +25^\circ C$, unless otherwise noted.)

MAX8862

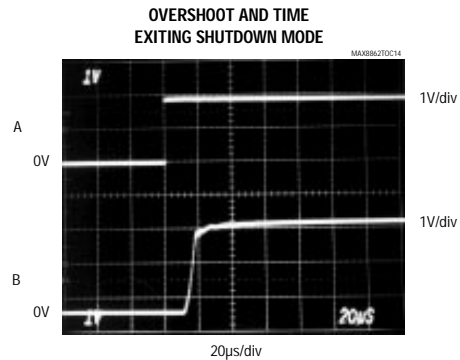
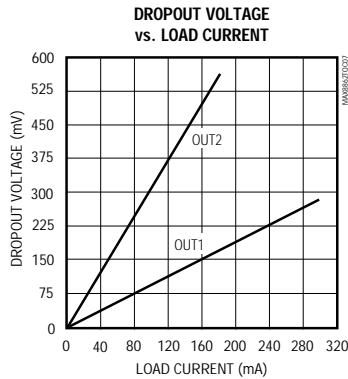
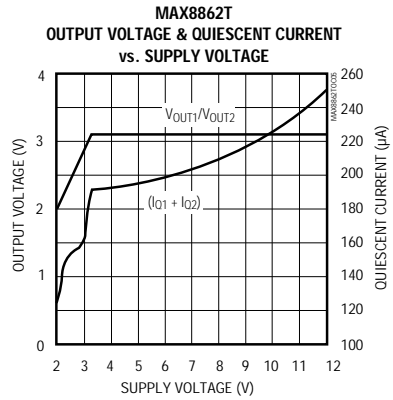
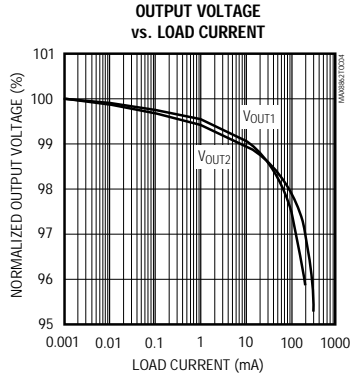
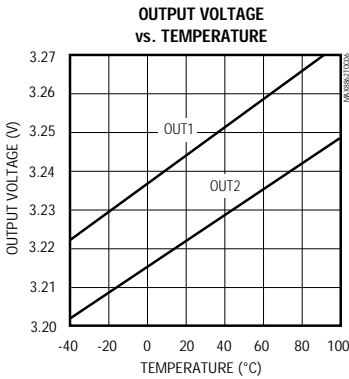
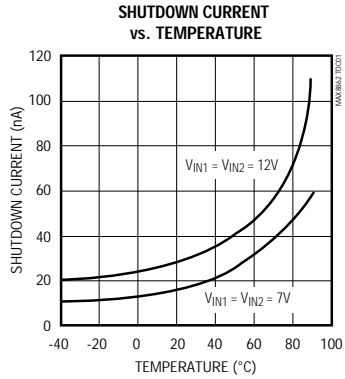
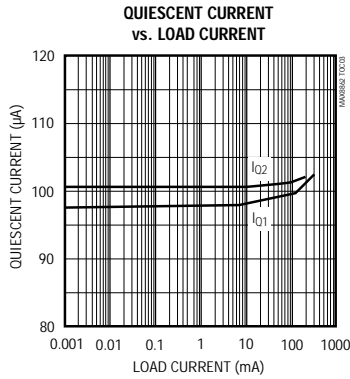
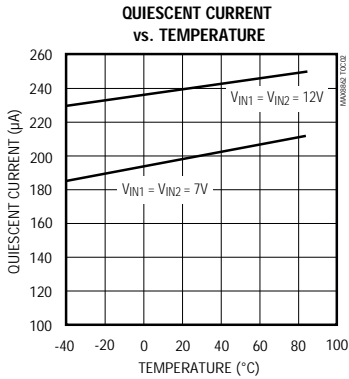

$V_{IN1} = 5.3V$, $I_{OUT1} = 5mA$
 A = SHDN1, 0.8V TO 2.4V, 1V/div
 B = OUT1, 1V/div

Low-Cost, Low-Dropout, Dual Linear Regulator

Typical Operating Characteristics (continued)

($V_{IN1} = V_{IN2} = 5.3V$, $C_{IN1} = C_{IN2} = 1\mu F$, $C_{OUT1} = 3.3\mu F$, $C_{OUT2} = 2.2\mu F$, $\overline{SHDN1} = IN1$, $\overline{SHDN2} = IN2$. $T_A = +25^\circ C$, unless otherwise noted.)

OUT1 NOISE AND RIPPLE

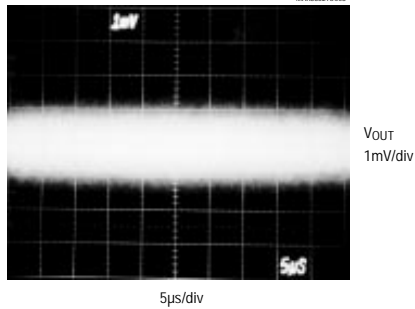

$I_{OUT1} = 250mA$, AC COUPLED

OUT2 NOISE AND RIPPLE

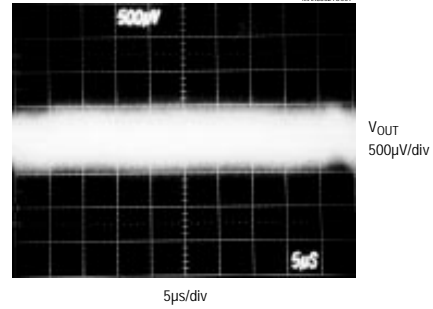

$I_{OUT2} = 100mA$, AC COUPLED

OUT1 LOAD-TRANSIENT RESPONSE

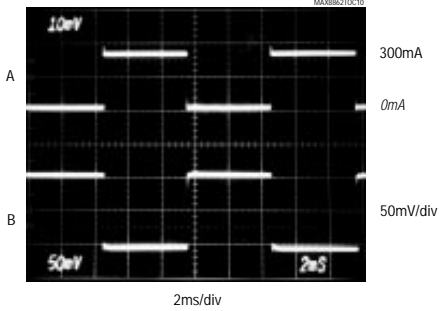

$V_{IN1} = 7V$, $V_{OUT1} = 3.2V$
 A = LOAD CURRENT, 0mA TO 300mA, 0.2A/div
 B = V_{OUT1} RIPPLE, 50mV/div, AC COUPLED

OUT2 LOAD-TRANSIENT RESPONSE

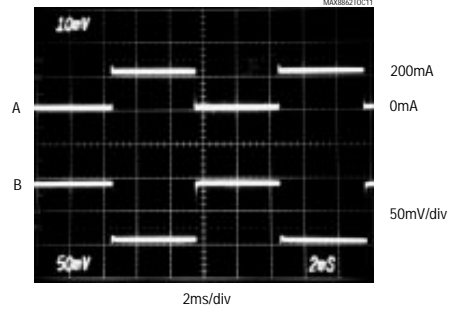

$V_{IN2} = 7V$, $V_{OUT2} = 3.2V$
 A = LOAD CURRENT, 0mA TO 200mA, 0.2A/div
 B = V_{OUT2} RIPPLE, 50mV/div, AC COUPLED

OUT2 LINE-TRANSIENT RESPONSE

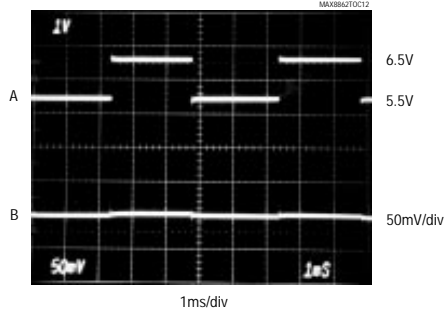

$I_{OUT2} = 200mA$, $V_{OUT2} = 3.2V$
 A = V_{IN2} , 5.5V TO 6.5V, 1V/div
 B = V_{OUT2} RIPPLE, 50mV/div, AC COUPLED

OUT1 LINE-TRANSIENT RESPONSE

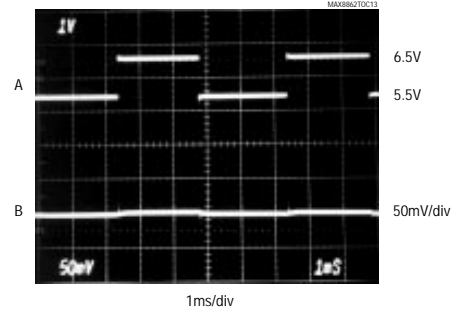

$I_{OUT1} = 300mA$, $V_{OUT1} = 3.2V$
 A = V_{IN1} , 5.5V TO 6.5V, 1V/div
 B = V_{OUT1} RIPPLE, 50mV/div, AC COUPLED

Low-Cost, Low-Dropout, Dual Linear Regulator

Pin Description

MAX8862

PIN	NAME	FUNCTION
1	IN1	Main Regulator Supply Input (2.5V to 11.5V). Bypass with a 1 μ F, low-ESR capacitor to GND.
2	$\overline{\text{SHDN1}}$	Main Regulator Shutdown Input. A logic low turns off the main regulator and power-good comparator.
3	PWROK1	Power-Good Output. This open-drain output is low when V_{OUT1} is out of regulation (V_{OUT1} is 4% lower than its nominal value).
4, 5, 12, 13	GND	Ground. Connect to a ground plane to maximize thermal dissipation.
6	OUT2	Secondary Regulator Output. Bypass with a 2.2 μ F low-ESR (< 0.5 Ω) capacitor to GND. To improve load-transient response and noise performance, use a higher-value, lower-ESR capacitor.
7	SET2	OUT2 Voltage-Set Input. Connect to GND for the factory-preset output voltage. Connect to a resistive divider from OUT2 to GND for adjustable output voltage.
8, 16	N.C.	No connect. There is no internal connection to this pin.
9	IN2	Secondary Regulator Supply Input (2.5V to 11.5V). Bypass with a 1 μ F, low-ESR capacitor to GND.
10	$\overline{\text{SHDN2}}$	Secondary Regulator Shutdown Input. A logic-low input turns off the secondary regulator and the reference.
11	REF2	Secondary Reference Output. Bypass with a 0.1 μ F capacitor to GND.
14	OUT1	Main Regulator Output. Bypass with a 3.3 μ F, low-ESR (< 0.5 Ω) capacitor to GND. To improve load-transient response and noise performance, use a higher-value, lower-ESR capacitor.
15	SET1	OUT1 Voltage Set Input. Connect to GND for the factory-preset output voltage. Connect to a resistive divider from OUT1 to GND for adjustable output voltage.

Detailed Description

The MAX8862 features Dual Mode™ operation, allowing a fixed output of 4.95V (L), 3.175V (T), or 2.85V (R), or an adjustable output from 2V to 11V. The regulator's outputs, OUT1 and OUT2, supply 250mA and 100mA, respectively.

The block diagram (Figure 1) shows the contents of each regulator. Note that the main regulator provides a power-good indicator, and the secondary regulator's reference output voltage is available at REF2.

The 1.25V bandgap reference is connected to the error amplifier's inverting input. The error amplifier compares this reference with the selected feedback voltage and amplifies the difference. The MOSFET driver reads the error signal and applies the appropriate drive to the P-channel transistor. If the feedback voltage is lower than the reference, the pass transistor's gate is pulled lower, allowing more current to pass and increase the output voltage. If the feedback voltage is too high, the pass transistor's gate is pulled up, allowing less current to pass to the output.

The output voltage is fed back through either an internal resistor voltage divider connected to OUT1/OUT2, or an external resistor network connected to SET1/SET2. The Dual Mode comparator examines $V_{\text{SET1}}/V_{\text{SET2}}$ and selects the feedback path. If this voltage is below 40mV, internal feedback is used and the output voltage is regulated to the factory-preset voltage.

Internal P-Channel Pass Transistor

The MAX8862's P-channel pass transistor provides several advantages over similar designs using PNP pass transistors, including longer battery life.

The P-channel MOSFET requires no continuous base current, thereby reducing quiescent current considerably. PNP regulators normally waste a considerable amount of current in dropout when the pass transistor saturates; they also use high base-drive currents under large loads. The MAX8862 does not suffer from these problems: it consumes only 200 μ A of quiescent current for both regulators under light and heavy loads, as well as in dropout.

Low-Cost, Low-Dropout, Dual Linear Regulator

MAX8862

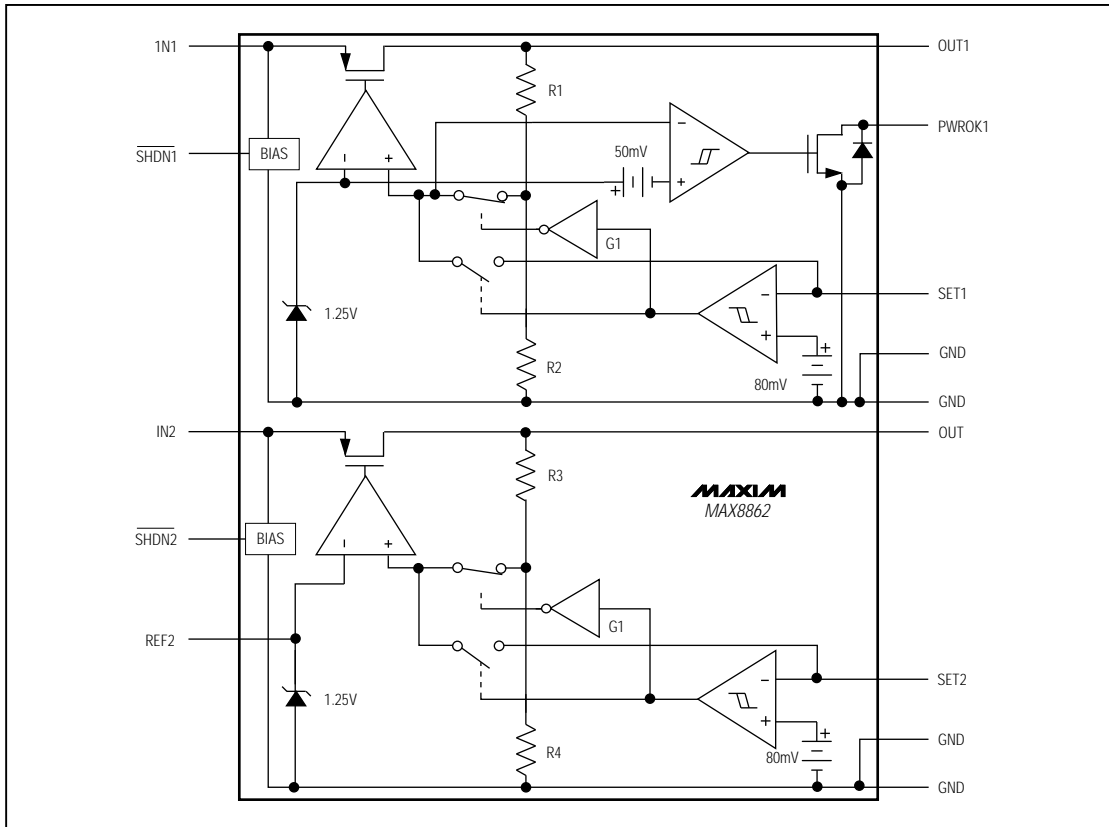

Figure 1. Functional Diagram

Output Voltage Selection

The MAX8862's Dual Mode operation allows a fixed or adjustable output voltage. In preset/internal-feedback mode (SET1/SET2 = GND), output voltages are factory preset to 4.95V (L), 3.175V (T), or 2.85V (R).

In adjustable/external feedback mode, output voltage is adjusted between 2V and 11V with two external resistors connected as a voltage divider to SET1/SET2 (Figure 2). Since the input bias current at SET1/SET2 is <math><0.1\mu\text{A}</math>, large resistance values can be used for R1 and R2 to minimize power consumption without losing accuracy. Select R2 in the 10k Ω to 400k Ω range. R1 is given by:

$$R1 = R2 (V_{OUT} / V_{SET} - 1)$$

where $V_{SET} = 1.25\text{V}$.

Power-Good Comparator

The MAX8862's main regulator features a power-good indicator that asserts when the output voltage falls out of regulation. In internal-feedback mode, the open-drain PWROK1 output goes low when OUT1 falls 4% below its nominal value. When used in external feedback mode, PWROK1 goes low when V_{SET1} falls below 1.2V. A 100k Ω pull-up resistor from PWROK1 to V_{IN1} provides a logic-control signal. This resistor also minimizes current flow to the input in case the battery is reversed. PWROK1 can be used to reset a microcontroller or to drive an external LED for indicating a power failure.

Low-Cost, Low-Dropout, Dual Linear Regulator

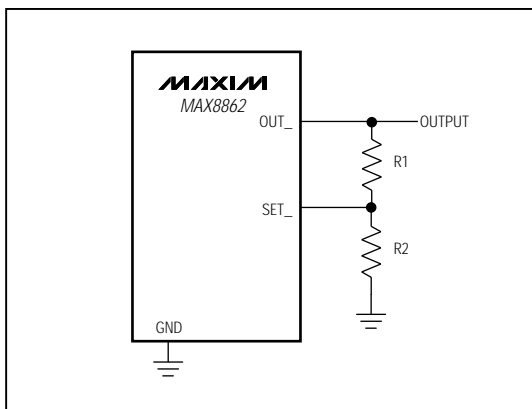

Figure 2. Adjustable Output Voltage

Reference

The MAX8862 provides a precision 1.25V reference at REF2. Bypass REF2 with a 0.1μF capacitor to ground. Larger bypassing capacitors will further reduce the secondary regulator's wideband noise.

Shutdown

The MAX8862's regulators have individual shutdown controls. A logic low on either $\overline{\text{SHDN1}}$ or $\overline{\text{SHDN2}}$ turns off the corresponding internal reference, error comparator, and pass transistors' control logic, reducing quiescent current to less than 1μA.

Current Limiting

The MAX8862 features a current limit for each regulator. It monitors and controls the pass transistor's gate voltage, limiting the output current to 580mA for the main regulator and 250mA for the secondary regulator. The current limits apply to all input and output voltage conditions. The outputs can be shorted to ground for an indefinite period of time if the package can dissipate ($V_{IN1} \times I_{LIM1} + V_{IN2} \times I_{LIM2}$) without exceeding $T_J = +150^\circ\text{C}$ (see the *Power Dissipation and Operating Region* section).

Thermal Overload Protection

Thermal overload protection limits the MAX8862's total power dissipation. When the junction temperature exceeds $T_J = +160^\circ\text{C}$, the thermal sensor sends a signal to the shutdown logic, turning off the pass transistors and allowing the device to cool down. The thermal sensor turns the pass transistors on again after the IC's junction temperature decreases by 20°C . If the thermal overload condition persists, OUT1 and OUT2 pulse on and off.

Thermal overload protection is designed to protect the MAX8862 during fault conditions. For continuous operation, the absolute maximum junction temperature rating of $T_J = +150^\circ\text{C}$ should not be exceeded.

Reverse-Battery Protection

This feature protects the MAX8862 against polarity reversal at the supply inputs. The inputs can handle negative voltages up to -12V without suffering any ill effects. When the input polarity is reversed, the output will be at the same potential as ground, and no current will flow from the output back to the input. This feature protects both the device and the supply-voltage source. The reverse currents that flow back to the input are due to R_{PWROK1} , R_{SHDN1} , and R_{SHDN2} . These currents are approximately: $I_{REV1} = |V_{IN1}| / (R_{SHDN1} + R_{PWROK1})$ and $I_{REV2} = |V_{IN2}| / R_{SHDN2}$. When operating the MAX8862 in continuous mode ($V_{\overline{\text{SHDN1}}} = V_{IN1}$ and $V_{\overline{\text{SHDN2}}} = V_{IN2}$) place a resistor ($>20\text{k}\Omega$) between shutdown and supply inputs to limit the current flow in case the battery is reversed.

MAX8862

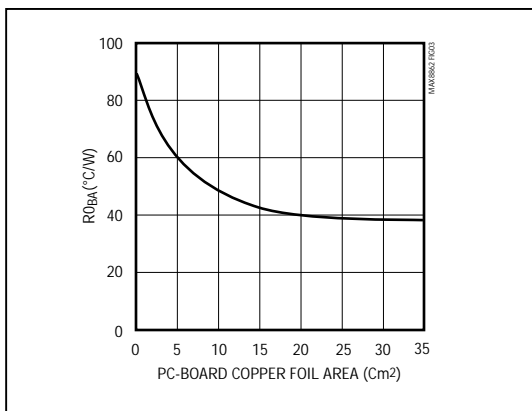

Figure 3. Typical Copper Thermal Resistance vs. Copper Ground Pad Area

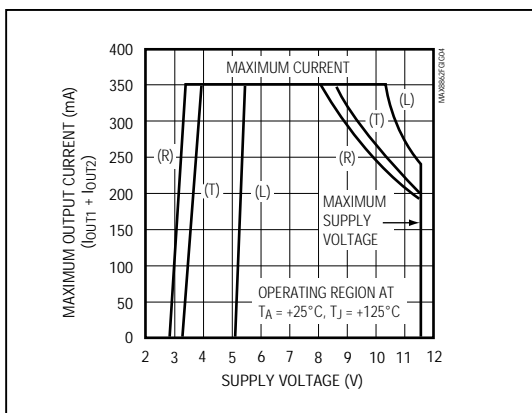

Figure 4. Safe Operating Regions: Main and Secondary Regulators Maximum Output Current vs. Supply Voltage

Applications Information

Power Dissipation and Operating Region

The MAX8862's maximum power dissipation depends on the thermal resistance of the case and circuit board, the temperature difference between the die junction and ambient air, and the rate of air flow.

The GND pins of the MAX8862 SO package perform the dual function of providing an electrical connection to ground and channeling heat away. Connect all GND

pins to ground using a large pad or ground plane. Where this is impossible, place a copper plane on an adjacent layer. For a given power dissipation, the pad should exceed the associated dimensions in Figure 3. This figure shows a typical thermal resistance for a 35 μ m-thick copper foil as a function of its area¹.

The power dissipation across the device is given by:

$$P = I_{OUT1}(V_{IN1} - V_{OUT1}) + I_{OUT2}(V_{IN2} - V_{OUT2})$$

The resulting power dissipation is as follows:

$$P = (T_J - T_A) / (\theta_{JB} + \theta_{BA})$$

where $(T_J - T_A)$ is the temperature difference between the MAX8862 die junction and the surrounding air, θ_{JB} (or θ_{JC}) is the thermal resistance of the package, and θ_{BA} is the thermal resistance through the printed circuit board, copper traces, and other materials to the surrounding air. The MAX8862's narrow SO package has a thermal resistance of $\theta_{JB} = +50^\circ\text{C/W}$.

The MAX8862 regulators deliver the rated output currents and operate with input voltages up to 11.5V, but not simultaneously. High output currents can only be sustained when input-output differential voltages are small, as shown in Figure 4.

Capacitor Selection and Regulator Stability

Filter capacitors are required at the MAX8862's inputs and outputs. 1 μ F ceramic capacitors are required at the inputs. The minimum output capacitance required for stability is 3.3 μ F for OUT1 and 2.2 μ F for OUT2. The capacitor values depend primarily on the desired power-up time and load-transient response. Load-transient response is improved by using larger capacitor values. Input and output filter capacitors should be soldered directly to pins to minimize lead inductance of PC board traces.

The output capacitor's equivalent series resistance (ESR) affects stability and output noise. Surface-mount ceramic capacitors have a very low ESR and are available up to 10 μ F. Otherwise, other low-ESR (<0.5 Ω) capacitors should be used. If the selected capacitor's ESR is higher than the recommended value, the capacitor value should be increased proportionally to maintain minimum output noise under all input voltage and output load conditions. Paralleling two or more capacitors also results in lower ESR.

¹This graph was generated by Mr. Kieran O'Malley of Cherry Semiconductor Corp. and was published in the October 26, 1995, issue of EDN magazine.

Low-Cost, Low-Dropout, Dual Linear Regulator

MAX8862

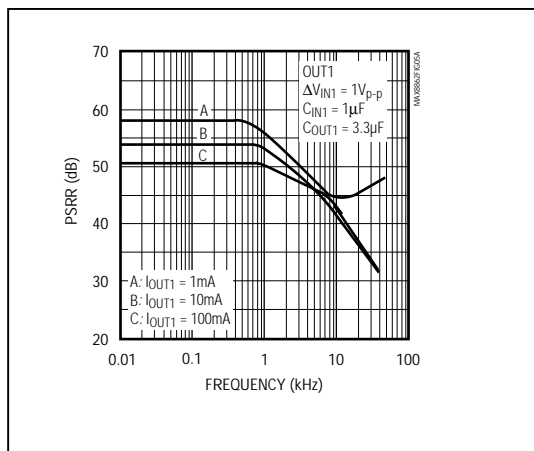

Figure 5a. Power-Supply Rejection Ratio vs. Ripple Frequency for Light and Heavy Loads

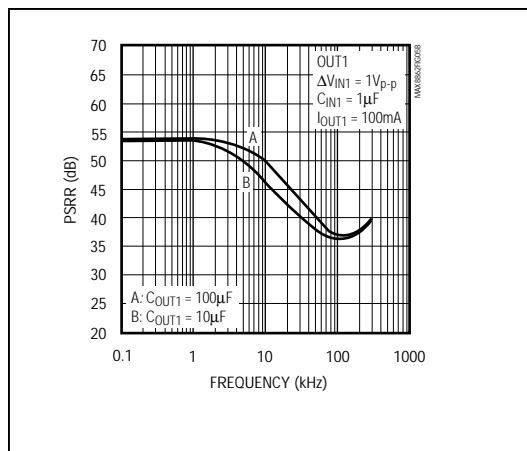

Figure 5b. Power-Supply Rejection Ratio vs. Ripple Frequency for Various Output Capacitors

Noise

The MAX8862's OUT1 exhibits about 2.5mVp-p, and OUT2 exhibits 1mVp-p of noise under full-load conditions. When using the MAX8862 for applications that include analog-to-digital converters (ADCs) with resolutions greater than 12 bits, consider the ADC's power-supply-rejection specifications.

PSRR and Operation from Sources Other than Batteries

The MAX8862 is designed to achieve low dropout voltages and low quiescent currents in battery-powered systems. However, to gain these benefits; the device must trade away power-supply noise rejection, as well as swift response to supply variations and load transients. For a 1mA load current, power-supply rejection typically changes from 58dB to 43dB when the input frequency is changed from 1Hz to 10kHz. At higher frequencies, the circuit depends primarily on the output capacitor's characteristics, and the PSRR increases (Figure 5).

When operating from sources other than batteries, supply-noise rejection and transient response can be improved by increasing the value of the input and output capacitors and employing passive filtering techniques. Do not use power supplies with ripple voltages exceeding 200mV at 100kHz.

Overshoot and Transient Considerations

The *Typical Operating Characteristics* section shows power-up, line, and load-transient response graphs. Typical transients for step changes in the load current from 0mA to 300mA are 100mVp-p. During recovery from shutdown, overshoot is minimized by the 1μF input, and output capacitors (3.3μF for OUT1, and 2.2μF for OUT2).

Input-Output (Dropout) Voltage

A regulator's minimum input-to-output voltage differential (or dropout voltage) determines the lowest usable supply voltage. In battery-powered systems, this determines the useful end-of-life battery voltage. Since P-channel MOSFETs are used as pass transistors, the dropout voltage is the product of the $R_{DS(ON)}$ and the load current (see the *Electrical Characteristics*).

Chip Information

TRANSISTOR COUNT: 457

Low-Cost, Low-Dropout, Dual Linear Regulator

MAX8862

Package Information

**Narrow SO
SMALL-OUTLINE
PACKAGE
(0.150 in.)**

DIM	INCHES		MILLIMETERS	
	MIN	MAX	MIN	MAX
A	0.053	0.069	1.35	1.75
A1	0.004	0.010	0.10	0.25
B	0.014	0.019	0.35	0.49
C	0.007	0.010	0.19	0.25
E	0.150	0.157	3.80	4.00
e	0.050		1.27	
H	0.228	0.244	5.80	6.20
L	0.016	0.050	0.40	1.27

DIM	PINS	INCHES		MILLIMETERS	
		MIN	MAX	MIN	MAX
D	8	0.189	0.197	4.80	5.00
D	14	0.337	0.344	8.55	8.75
D	16	0.386	0.394	9.80	10.00

21-0041A

Maxim cannot assume responsibility for use of any circuitry other than circuitry entirely embodied in a Maxim product. No circuit patent licenses are implied. Maxim reserves the right to change the circuitry and specifications without notice at any time.

12 _____ Maxim Integrated Products, 120 San Gabriel Drive, Sunnyvale, CA 94086 (408) 737-7600

© 1996 Maxim Integrated Products

Printed USA

MAXIM is a registered trademark of Maxim Integrated Products.